

Accessories & Spare Parts

Clamping and cutting technology, July 1 2019

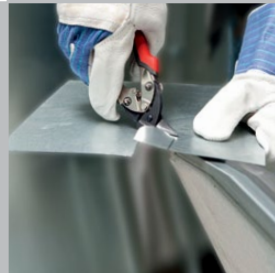

Simply better.

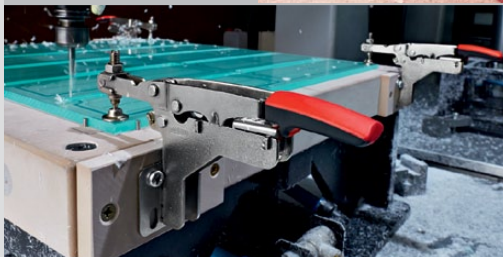
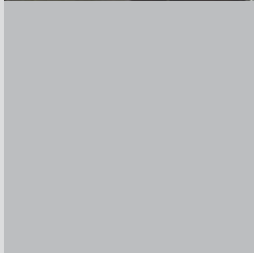

BESSEY® 2019 Accessories & spare parts

3 Malleable cast iron screw clamps



TG
TGJ
TGK
CDS

4 All-steel screw clamps



660
1200
J18-8
SGL, SQ, STB

4 OMEGA screw clamp



RSC

5 Lever clamps



LC
GSH

6 High performance clamps



1800, 2400, 4800, 7200,
8500
SQ, SG30VAD

7 Variable screw clamps



SLV
GSV

8 Claw clamp



CL24

8 K Body REVO



KRE
KREV

9 One handed clamp



PG

9 Edge clamps



EKT
KF
KFP

9 Strap clamps



VAS

10 Grip pliers



SG4
SG8
SG24

10 Seaming tools



PS

10 Self-adjusting toggle clamps



STC-VH
STC-HH
STC-HV
STC-HA
STC-IHH
STC-IHA

11 Welding table clamps



TWV
TW
TWM
TWGR
TWVAD
TWA

12 Machine table clamps







BAS
BSN
1200HD
2400HD

12 Cutting tools

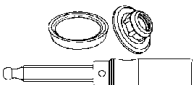
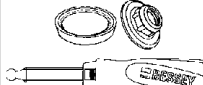

DBK
D24

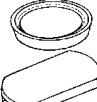
Sliding arm cpl. with 2-component plastic handle		Sliding arm cpl. with break/ wooden handle		Wood handle, incl. high-quality steel pressure plate with protection cap			2-component plastic handle, incl. high-quality steel pressure plate with protection cap			Pressure plate changeable from size 16		Protection cap for moveable jaw & for fixed jaw	
													
Throat depth mm	For rail mm	Throat depth mm	For rail mm	Length x Ø mm	Head Ø mm	Acme thread mm	Length x Ø mm	Head Ø mm	Acme thread mm	Ø mm	For Ø mm	For width mm	
										4 pcs./bag	10 pairs./bag		

Malleable cast bar clamps for TG series

TGJ							110 x 30	10	14 x 4	25.5	25.5	23	
Model no.							3101179			3101180	3101392		
TG4.0XX		100	27 x 7	112 x 30	12	16 x 4	110 x 30	12	16 x 4	32	32	28	
Model no.		3101413		3101386			3101182			3101183	3101394		
TG4.5XX	120	29 x 9	120	29 x 9	125 x 32	12	16 x 4	130 x 34	12	16 x 4	32	32	30
Model no.	3101832		3101414		3101389			3101186			3101183	3101395	
TG5.5XX	140	32 x 10	140	32 x 10	140 x 35	13	18 x 5	130 x 34	13	18 x 5	38.5	38.5	32
Model no.	3101833		3101415		3101390			3101187			3101188	3101396	
TG7.0XX	175	32 x 10	175	32 x 10	140 x 35	13	18 x 5	130 x 34	13	18 x 5	38.5	38.5	32
Model no.	3101834		3101416		3101390			3101187			3101188	3101396	

Heavy Duty malleable cast bar clamps for TGK series

TGK		120	35 x 11	140 x 35	13	18 x 5	130 x 34	13	18 x 5	38.5	25.5	23
Model no.		3101417		3101390			3101187			3101188	3101393	
TGK-K		120	35 x 11							38.5	25.5	23
Model no.		3101418								3101188	3101393	

Deep throat CDS clamps

							Tommy bar		BESSEY® Grip	
CDS24-10		250	40 x 11	140 x 35	13	18 x 5			38.5	
Model no.		3101420		3101390			3101797		3101188	3101194
CDS24-12		300	45 x 12	140 x 35	13	18 x 5			38.5	
Model no.		3101421		3101390			3101797		3101188	3101194
CDS24-20				140 x 35	13	18 x 5			38.5	
Model no.				3101390			3101797		3101188	3101194

BESSEY® 2019 Accessories & spare parts

Sliding arm cpl. with wooden handle		Sliding arm cpl. with tommy bar		Wood handle, incl. high-quality steel pressure plate with protection cap			2-component plastic handle, incl. high-quality steel pressure plate with protection cap			Tommy bar	Pressure plate changeable from size 16
Throat depth mm	For rail mm	Throat depth mm	For rail mm	Length x Ø mm	Head Ø mm	Acme thread mm	Length x Ø mm	Head Ø mm	Acme thread mm	Acme thread mm	Ø mm

All-steel bar clamps (version 01.07.09) – New Profile

660	100	22 x 8.5	100	22 x 8.5	112 x 30	12	16 x 4	110 x 30	12	16 x 4	16 x 4	32
Model no.	3101516		3101441		3101386			3101182			3101796	3101183
1200-S8 1200-S12	140	28 x 11	140	28 x 11	140 x 35	13	18 x 5	130 x 34	13	18 x 5	18 x 5	38.5
Model no.	3101518		3101447		3101390			3101187			3101797	3101188
1200-S18 1200-S24	120	28 x 11	120	28 x 11	140 x 35	13	18 x 5	130 x 34	13	18 x 5	18 x 5	38.5
Model no.	3101519		3101450		3101390			3101187			3101797	3101188

OMEGA classiX® and All-steel bar clamps (up to version 30.06.09) – Classic Profile

GS16K GS12-8K								110 x 30	10	14 x 4	16 x 4	25.5
Model no.								3101179			3101795	3101180
GS20K RSC-8	100	19.5 x 9.5	100	19.5 x 9.5	112 x 30	12	16 x 4	110 x 30	12	16 x 4	16 x 4	32
Model no.	3101422		3101800		3101386			3101182			3101796	3101183
SQ-4 J18-8 GS25K GS16-12K	120	22 x 10.5	120	22 x 10.5	125 x 32	12	16 x 4	130 x 34	12	16 x 4	16 x 4	32
Model no.	3101423		3101801		3101389			3101186			3101796	3101183
1200S-12 GS30K RSC-12	140	25 x 12	140	25 x 12	140 x 35	13	18 x 5	130 x 34	13	18 x 5	18 x 5	38.5
Model no.	3101424		3101802		3101390			3101187			3101797	3101188
1200S-8 GS60K RSC-18 RSC-24	120	25 x 12	120	25 x 12	140 x 35	13	18 x 5	130 x 34	13	18 x 5	18 x 5	38.5
Model no.	3101425		3101803		3101390			3101187			3101797	3101188
SGL	120	27 x 13	120	27 x 13	140 x 35	13	18 x 5	130 x 34	13	18 x 5	18 x 5	38.5
Model no.	3101426		3101804		3101390			3101187			3101797	3101188

BESSEY® 2019 Accessories & spare parts

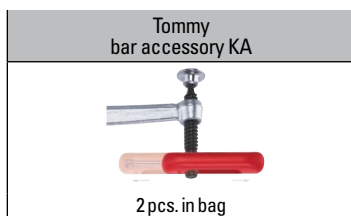

suitable for:

TG & TB, RSC-8, 660S, SQ-4

Model no.	3101194
-----------	---------

RSC-12, RSC-18, RSC-24, 1200, SQ, SGL, SG30VAD, 2400

Model no.	3101195
-----------	---------

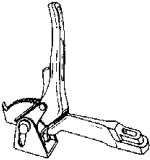
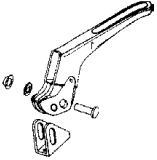
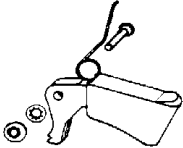
Sliding arm cpl.		Lever pressure plate cpl.	Trigger cpl.
			
Throat depth mm	For rail mm	Bolt Ø x 1 mm	2 pcs. in bag Bolt Ø x 1 mm

Lever clamps (version 01.03.10) for LC series – New Profile

LC4				5h11 x 21
Model no.				3101399
LC8	100	22 x 8.5	10 x 33.5	5h11 x 26
Model no.	3101522		3101397	3101400
LC12	140	28 x 11	12 x 38	5h11 x 26
Model no.	3101524		3101398	3101401
LC20 LC31	120	28 x 11	12 x 38	5h11 x 26
Model no.	3101525		3101398	3101401

Lever clamps (up to version 28.02.10) for GSH series – Classic Profile

GSH12/LC-4				5h11 x 21
Model no.				3101399
GSH20/LC-8	100	19.5 x 9.5	10 x 33.5	5h11 x 26
Model no.	3101333		3101397	3101400
GSH30/LC-12	140	25 x 12	12 x 38	5h11 x 26
Model no.	3101335		3101398	3101401
GSH50/LC-20	120	25 x 12	12 x 38	5h11 x 26
Model no.	3101336		3101398	3101401

BESSEY® 2019 Accessories & spare parts

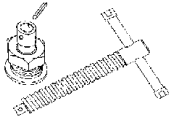



Sliding arm cpl.		Kombi set (screw, pressure plate cpl. & pressure pin)	
			
Throat depth mm	For rail mm	Acme thread mm	Tommy bar Ø x length mm

High performance clamps (version 01.07.08) – New Profile

1800	120	28 x 11	18 x 5	10 x 120
Model no.	3101521		3100398	
2400	140	34 x 13	20 x 5	11 x 120
Model no.	3101407		3100399	

High performance clamps (up to version 30.06.08) – Classic Profile

1800, GSL	120	27 x 13	18 x 5	10 x 120
Model no.	3101338		3100398	
SQ	120	30 x 15	20 x 5	11 x 120
Model no.	3101329		3100399	
2400, GSM	140	30 x 15	20 x 5	11 x 120
Model no.	3101330		3100399	
DT 2400	200	30 x 15	20 x 5	11 x 120
Model no.	3101331		3100399	
4800	175	40 x 20	22 x 5	11 x 180
Model no.	3101332		3100400	
7200	200	50 x 25	M24	18 x 345
Model no.	3101798		3100401	
8500	100	40 x 20	22 x 5	11 x 180
Model no.	3100753		3100400	
SG30VAD	120	30 x 15	20 x 5	11 x 120
Model no.	3101724		3100399	

Regular high performance pressure plate		Rough surface high performance pressure plate		V-groove high performance pressure plate		Socket/ bushing with spring ring	Wedge 7200S
							
Screw hole mm	Pin mm	Screw hole mm	Pin mm	Screw hole mm	Pin mm	Thread mm	2 pcs. in bag

High performance clamps

SGL, SQ, 1800, 2400, 4800, 8500	12	5 x 20	12	5 x 20	12	5 x 20	
Model no.	3100736		3101192		3101193		
7200 + any spindle that accepts a regular MorPad	12	5 x 20				M24	
Model no.	3100737					3100579	3101788

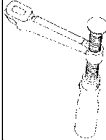
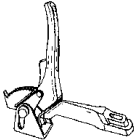
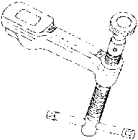
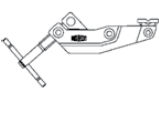
Rail		Wooden handle cpl.		Lever clamp cpl.		Tommy bar cpl.		Gripping arm cpl.	
									
Opening mm	Rail mm	Throat depth mm	For rail mm	Throat depth mm	For rail mm	Throat depth mm	For rail mm	Throat depth mm	For rail mm

Versatile clamp set 3m opening (up to version 31.03.2015)

SLV100M			120	28 x 11	120	28 x 11	120	28 x 11	120	28 x 11
Model no.			3101519		3101525		3101521		3101590	
SLV100M			140	28 x 11	140	28 x 11				
Model no.			3101518		3101524					
SLV150M			120	28 x 11	120	28 x 11	120	28 x 11	120	28 x 11
Model no.			3101519		3101525		3101521		3101590	
SLV150M			140	28 x 11	140	28 x 11				
Model no.			3101518		3101524					
SLV200M			120	28 x 11	120	28 x 11	120	28 x 11	120	28 x 11
Model no.			3101519		3101525		3101521		3101590	
SLV200M			140	28 x 11	140	28 x 11				
Model no.			3101518		3101524					
GSV200M	3000	30 x 15					120	30 x 15		
Model no.	3101612						3101329			
GSV200M	3000	30 x 15					140	30 x 15		
Model no.	3101612						3101330			
GSV200M	3000	30 x 15					200	30 x 15		
Model no.	3101612						3101331			

Versatile clamp set 3m opening (from version 01.04.2015) – Classic Profile

SLV100M	1000	27 x 13	120	27 x 13	120	27 x 13	120	27 x 13		
Model no.	3101731		3101426		3101337		3101338			
SLV150M	1500	27 x 13	120	27 x 13	120	27 x 13	120	27 x 13		
Model no.	3101732		3101426		3101337		3101338			
SLV200M	2000	27 x 13	120	27 x 13	120	27 x 13	120	27 x 13		
Model no.	3101733		3101426		3101337		3101338			
GSV200M	3000	30 x 15					120	30 x 15		
Model no.	3101612						3101329			
GSV200M	3000	30 x 15					140	30 x 15		
Model no.	3101612						3101330			
GSV200M	3000	30 x 15					200	30 x 15		
Model no.	3101612						3101331			

SLV/GSV rail end stop fastener set

SLV / GSV	
Model no.	3101782

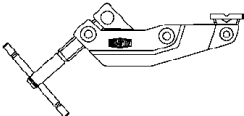
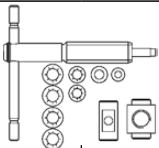

BESSEY® 2019 Accessories & spare parts

Sliding arm cpl.		Screw cpl.	
			
Throat depth mm	For rail mm	Acme thread mm	Tommy bar Ø x length mm



Claw clamp (version from 01.04.12)

CL24	120	28 x 11	18 x 5	8 x 110
Model no.	3101590		3101562	

Sliding arm cpl. with plastic case	
	
Throat depth mm	For rail mm

K-Body clamps KR / KRV / KRE / KREV

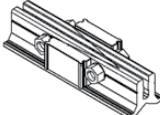
KR...-2K KRV...-2K	85	29 x 9
Model no.	KRE-J2K	

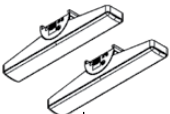
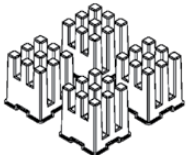
Extender	Variable Jaw	Tilting adapter	Framing set
			
		Jaw width mm	Jaw height mm

K-Body clamps KR / KRV

K...				
Model no.	KBX20	KRE-VO		KP
KR...-2K KRV...-2K			170	25
Model no.	KBX20	KRE-VO	KR-AS	KP

Protection cap set.	Protection cap set.
<p>5 pairs Ø mm</p>	<p>10 pcs.</p>

One-handed clamp Power Grip

PG	32	
Model no.	3101402	
EZS		40 x 48
Model no.		3101841

Repair kit	Jaw cpl. with push rod
<p>3 pairs x large jaws, 3x protection caps</p>	<p>2 pair</p>

One-handed edge clamp EKT

EKT55	3101403	3100998
-------	---------	---------

Jaws
<p>1 pair including spring</p>

Kantenfix KF and panel carrier KFP

KF2	4102100
KF4	4102056
KFP	4102057

Clamping strap spare part / enlarger
<p>Strap 7100 mm, 2 buckles</p>

Band clamps VAS-23

VAS-23	3100832
--------	---------

Pressure plate with protection cap
<p>5 pairs Ø mm</p>

GearKlamp GK



GK	26
Model no.	3101840

BESSEY® 2019 Accessories & spare parts



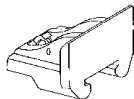

Grip pliers SG

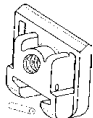
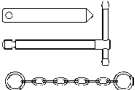
SG4, SG8	3100576	
SG24-PC		3101547

Pressure jaw TB		Screw guide	Clamplng jaw	Screw set TB
				
Jaw width mm	Jaw height mm	Acme thread mm		

Sash clamps TB

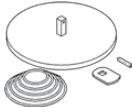
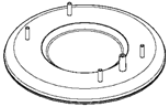
TB	68	48	18 x 5		
Model no.	3101793	3101792	3100920	3101405	

Vacuum adapter	Rubber pad	Handle
 Ø mm	 Ø mm	

Seaming tools PS

PS55	120		
Model no.	3101839		
PS120		210	
Model no.		3101685	3101686

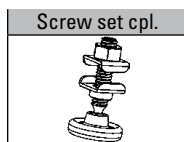

Toggle clamps STC

STC-VH20 STC-HH20 STC-HV20 STC-HA20 STC-IHH15 STC-IHA20	3101627
STC-VH50 STC-HH50 STC-IHH25	3101589
STC-HH70	3101588



Rail		Cross holder cpl.	2K handle cpl.		Tommy bar cpl.		Lever handle cpl.	
								
Opening mm	Rail mm		Throat depth mm	For rail mm	Throat depth mm	For rail mm	Throat depth mm	For rail mm

Table welding clamps TWV

TWV16	200	22 x 8 ½	22 x 8 ½	- 150	22 x 8 ½	- 150	22 x 8 ½	- 150	22 x 8 ½
Model no.	3101740		3101744	3101741		3101742		3101743	
TWV28	300	28 x 11	28 x 11	40 - 175	28 x 11	40 - 175	28 x 11	110 - 175	28 x 11
Model no.	3101706		3101710	3101707		3101708		3101709	

Table welding clamps TW

TW16	200	22 x 8 ½		100	22 x 8 ½	100	22 x 8 ½	100	22 x 8 ½
Model no.	3101740			3101516		3101441		3101522	
TW28	300	28 x 11		120	28 x 11	120	28 x 11	120	28 x 11
Model no.	3101706			3101519		3101450		3101525	
TW28	300	28 x 11		140	28 x 11	140	28 x 11	140	28 x 11
Model no.	3101706			3101518		3101447		3101524	

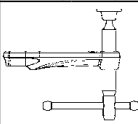
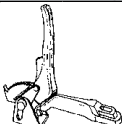





Tommy bar cpl.		Regular high performance pressure plate		Rough surface high performance pressure plate		V-groove high performance pressure plate		Rail		Arm	
											
Throat depth mm	For rail mm	Screw hole mm	Pin mm	Screw hole mm	Pin mm	Screw hole mm	Pin mm	Opening mm	Rail mm	Throat depth mm	For rail mm

Table welding clamps TWM28

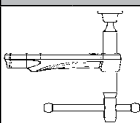
TWM28	120	28 x 11	12	5 x 20	12	5 x 20	12	5 x 20
Model no.	3101521		3100736		3101192		3101193	

Table welding clamps TWGRS

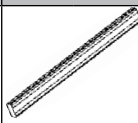
TW28GRS								200	22 x 11	120	28 x 11
Model no.								3101706		3101590	



Extension

Opening Ø	Adj.
-----------	------

Table welding clamps TWVAD / TWA-STC / TW28AV

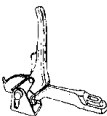
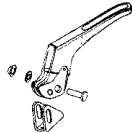
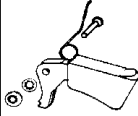

TWVAD, TW16VAD, TW16A-STC	16	15-200
Model no.	TW16X	
TWVAD, TW28VAD, TW28A-STC, TW28AV	28	15 - 300
Model no.	TW28X	

BESSEY® 2019 Accessories & spare parts

Clamping arm	Pressure shoe	Spindle	Sliding arm cpl.	Lever with pressure cap cpl.	Trigger cpl.
	 4 pcs. in bag	 2 pcs. in bag	 Throat depth mm For rail mm	 Bolt Ø x 1 mm	 2 pcs. in bag Bolt Ø x 1 mm



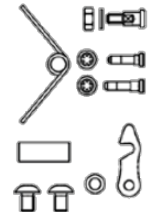

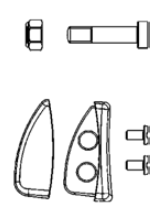
Machine table clamps BAS, BS, SGHS

BAS... 9-4	3101428	3101431	3101726			
BAS... 10-6	3101429	3101431	3101726			
BSP... 10-6	3101430		3101726			
BS2N/BS3N 1200HD-9 Model no.						5h11 x 26 3100747
BS4N Model no.						5h11 x 26 3100748
BS6N, 1800L, 2400HD-10 Model no.				140 3101432	30 x 15 12 x 38 3101029	

Repairing set 08/22A 27/29/123S	Repairing set 16	Lower hold complete 123S
		



Compound leverage snips

D22A, D27AH	R032		
D16, D16L, D16S		R030	
D27, D29	R001		
D123 S	R001		R042

Standard blade	Hook blade	Linoleum blade	Scoring blade
 10 pcs.	 10 pcs	 5 pcs	 5 pcs

Folding utility knife

DBKPH, DBKWH, DBKAH	DBK-T	DBK-H	DBK-L	DBK-A
---------------------	-------	-------	-------	-------

Replacement blades	Spare mould
	

Nibbler

D24	D241	Model no. D242
-----	------	----------------

Accessories & Spare Parts

Clamping and cutting technology, July 1 2017 / 2018



Simply better.



Join us on...



facebook.com/BesseyToolsNorthAmerica



instagram.com/BesseyTools_NA



twitter.com/BesseyTools



youtube.com/user/BesseyTools



besseytools.com



Sign up to receive our e-newsletter at
info@besseytools.com